

R11_-42LP_-4M-5150

Diameter:

420 mm

Nominal data according to standard EN 60335:

Phase	1~
Nominal voltage	230 V
Frequency	50 Hz
Rated power input	220 W
Rated current	1.00 A
Rated speed	1280 RPM
Min. ambient temperature	-30 °C
Max. ambient temperature	60 °C
Sound power level A weighted	76 dB (A)
Condensator	6.3 µF/450 V
Connection	terminal box
Insulation class	155
Protection class	IP54

ErP data according to EU regulation 327/2011:

Overall efficiency	28.9 %
Measurement category	A
Efficiency category	static
Efficiency grade N	39.2
Variable speed drive	NO
Power input	231 W
Air flow	2948 m³/h
Pressure drop	84 Pa
Speed	1259 RPM
Specific ratio	1.00

Aerodynamic characteristic

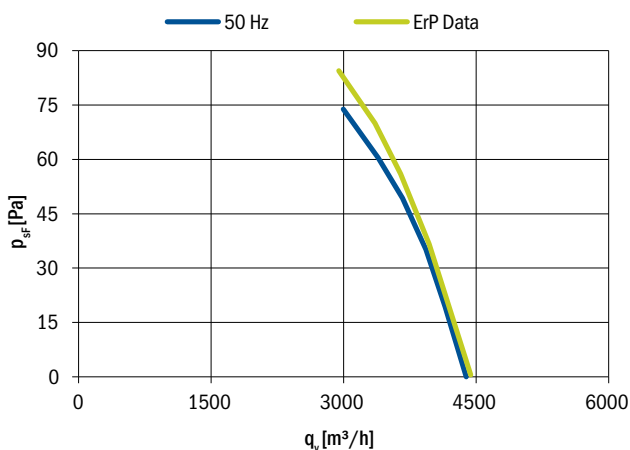

Fan characteristic measured in short bell mouth with guard grill.
ErP characteristic measured in full bell mouth without guard grill.

General notes

Connection diagrams:		
Sucking	0301-1-0044	See section
Blowing	0301-1-0043	Connection diagrams
Guard grills & wall-plates	See section Accessories	
Standards compliance	See introduction page	



Fan with guard grill

Airflow Direction	Type	Code	Weight (kg)
Sucking	R11R-42LPS-4M-5150	0311-4-0312	6.1
Blowing	R11R-42LPB-4M-5150	0311-4-0310	

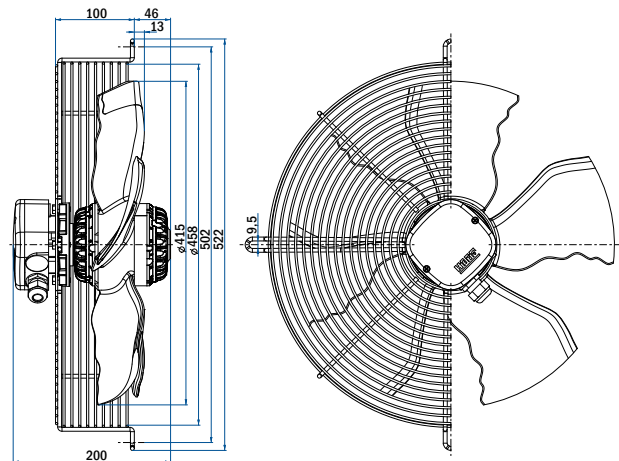

Fan with plate

Airflow Direction	Type	Code	Weight (kg)
Sucking	R11P-42LPS-4M-5150	On request	
Blowing	R11P-42LPB-4M-5150	On request	

Fan without guard grill

Airflow Direction	Type	Code	Weight (kg)
Sucking	R11E-42LPS-4M-5150	On request	
Blowing	R11E-42LPB-4M-5150	On request	