

"A12BW" SERIES COSTECH FANS

Description: **Axial fan a.c. 120X120x38mm**

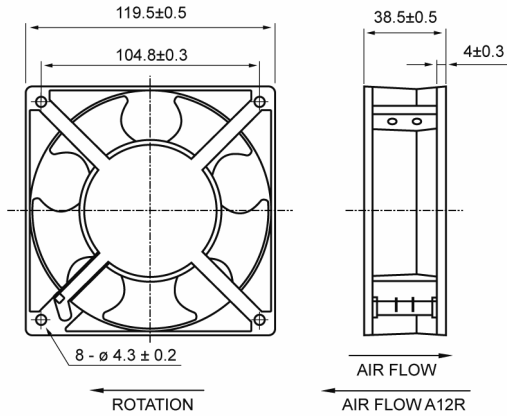

Casing material:

Impeller material

Protection degree:

Insulation class:

Fixing system:

Motor protection:

Storage temperature:

Rated temperature range:

Lifetime L10 at 40°C:

Electrical connection:

Weight:

Approvals:

die-casting aluminium painted black

black thermoplastic UL 94V-0

IP20, according to EN 60529 standard

A

4 holes Ø4.3 mm

impedance

from -40°C to +70°C

from -10°C to +60°C

30.000 h

flat terminals

0.550 kg

UL E223195; VDE 40009963

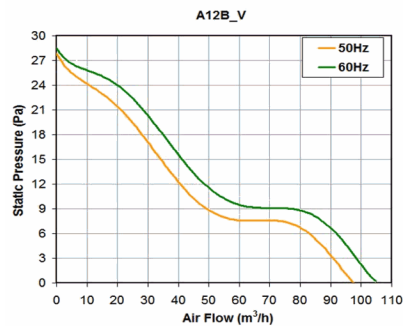
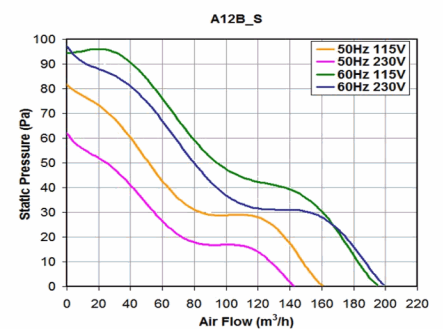
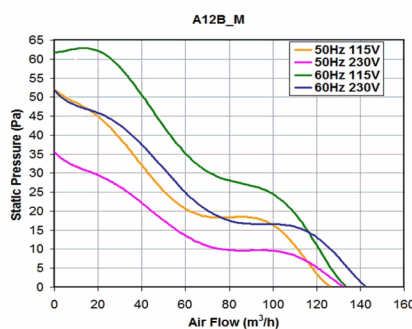
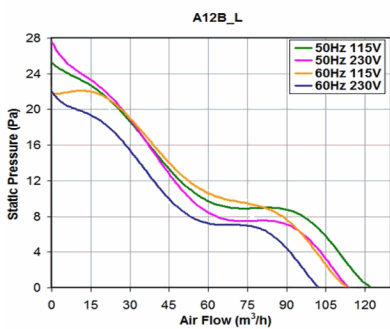
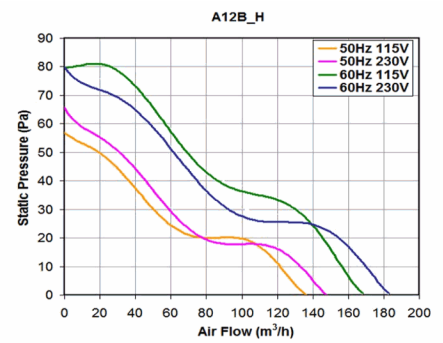
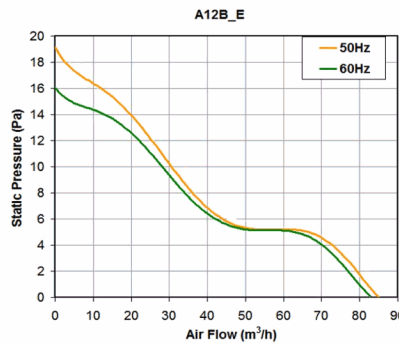
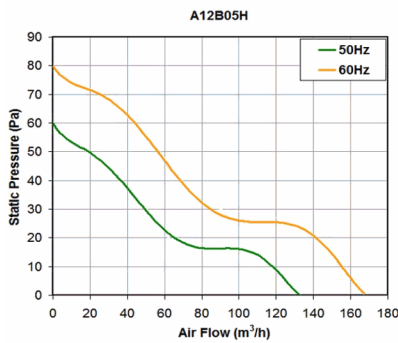

Model	Bearing	Voltage	Frequency	Rated Current	Rated Power	Max Air Flow	Static Pressure	Noise	RPM	Approvals
		(V)	(Hz)	(A)	(W)	(m ³ /h)	(Pa)	[db(A)]	(rpm)	
A12B12HTBW00	Ball	115 V a.c.	50/60	0.210/0.180	20/18	148/182	65/80	46.0/49.0	2,750/3,050	CE; cURus; VDE;
A12B12HTSW00	Sleeve	115 V a.c.	50/60	0.210/0.180	20/18	138/178	55/75	44.0/48.0	2,750/3,050	CE; cURus; VDE;
A12B12LTBW00	Ball	115 V a.c.	50/60	0.120/0.130	11/11	133/122	35/32	42.0/40.0	2,300/2,100	CE; cURus; VDE;
A12B12LTSW00	Sleeve	115 V a.c.	50/60	0.130/0.110	11/11	115/104	35/20	41.0/37.0	2,200/1,800	CE; cURus; VDE;
A12B12MTBW00	Ball	115 V a.c.	50/60	0.170/0.160	16/15	136/143	52/62	44.0/46.0	2,500/2,700	CE; cURus; VDE;
A12B12MTSW00	Sleeve	115 V a.c.	50/60	0.170/0.160	16/15	129/141	50/52	44.0/46.0	2,400/2,600	CE; cURus; VDE;
A12B12STBW00	Ball	115 V a.c.	50/60	0.260/0.240	22/20	165/182	75/95	48.0/50.0	2,850/3,150	CE; cURus; VDE;
A12B12STSW00	Sleeve	115 V a.c.	50/60	0.260/0.240	22/23.8	165/182	62/95	47.0/50.0	2,700/3,100	CE; cURus; VDE;
A12B12VTBW00	Ball	115 V a.c.	50/60	0.096/0.089	8.1/7.5	98/105	28/28	37.0/38.0	1,850/1,900	CE; VDE
A12B23ETBW00	Ball	230 V a.c.	50/60	0.035/0.035	6.5/6.0	83/82	16/16	29.0/28.0	1,500/1,450	CE; VDE
A12B23ETSW00	Sleeve	230 V a.c.	50/60	0.04/0.04	6.5/6.0	83/82	16/16	29.0/28.0	1,500/1,450	CE; VDE
A12B23HTBW00	Ball	230 V a.c.	50/60	0.130/0.110	20/19	139/182	60/80	46.0/49.0	2,750/3,050	CE; cURus; VDE;
A12B23HTSW00	Sleeve	230 V a.c.	50/60	0.130/0.110	20/19	138/178	55/75	44.0/48.0	2,55/2,900	CE; cURus; VDE;
A12B23LTBW00	Ball	230 V a.c.	50/60	0.050/0.060	11/10	114/102	27/22	44.0/42.0	2,200/1,800	CE; cURus; VDE;
A12B23LTSW00	Sleeve	230 V a.c.	50/60	0.050/0.060	11/10	115/104	35/20	41.0/37.0	2,200/1,800	CE; cURus; VDE;
A12B23MTBW00	Ball	230 V a.c.	50/60	0.090/0.080	16/15	133/143	47/57	43.0/45.0	2,400/2,600	CE; cURus; VDE;
A12B23MTSW00	Sleeve	230 V a.c.	50/60	0.090/0.080	16/15	129/141	50/52	44.0/46.0	2,300/2,500	CE; cURus; VDE;
A12B23STBW00	Ball	230 V a.c.	50/60	0.140/0.120	22/21	143/199	62/97	47.0/50.0	2,700/3,100	CE; cURus; VDE;
A12B23STSW00	Sleeve	230 V a.c.	50/60	0.140/0.120	22/21	141/182	62/95	47.0/50.0	2,600/3,100	CE; cURus; VDE;
A12B23VTBW00	Ball	230 V a.c.	50/60	0.050/0.050	10/10	98/105	27/27	37.0/38.0	1,850/1,900	CE; VDE;
A12B05HTBW00	Ball	24 V a.c.	50/60	0.80/0.77	14/14	129/142	55/40	45.0/48.0	2,550/2,800	CE;
A12B05HTSW00	Sleeve	24 V a.c.	50/60	0.75/0.73	13.2/13.2	147/142	55/50	46.0/45.0	2,530/2,430	CE;
A12B05LTBW00	Ball	24 V a.c.	50/60	0.71/0.65	13/12	105/115	30/30	38.0/40.0	1,920/2,090	CE;

data with uncertainty of 15%